



PORTAFOLIO SISTEMAS ARQUITECTÓNICOS



www.vialcor.com

PERFILERÍA EN VENTANA 5020 (VISTA EXTERIOR)

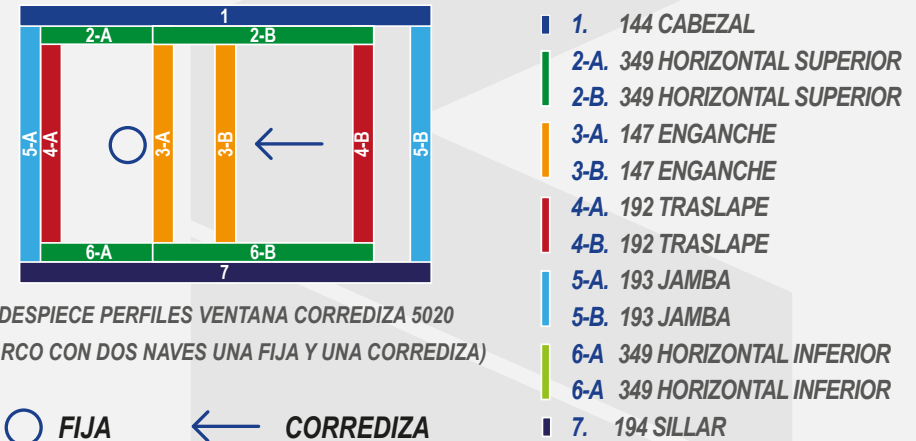
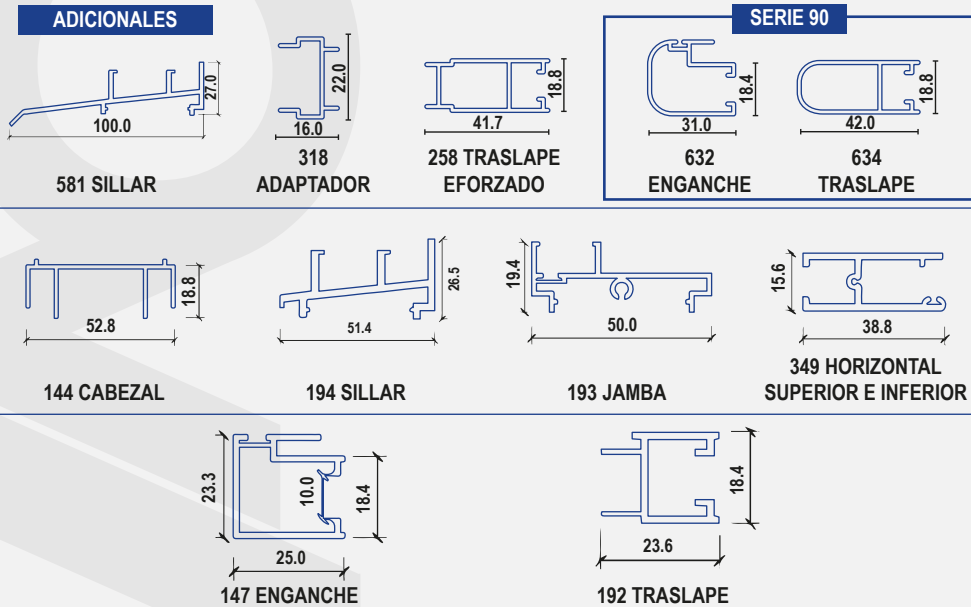
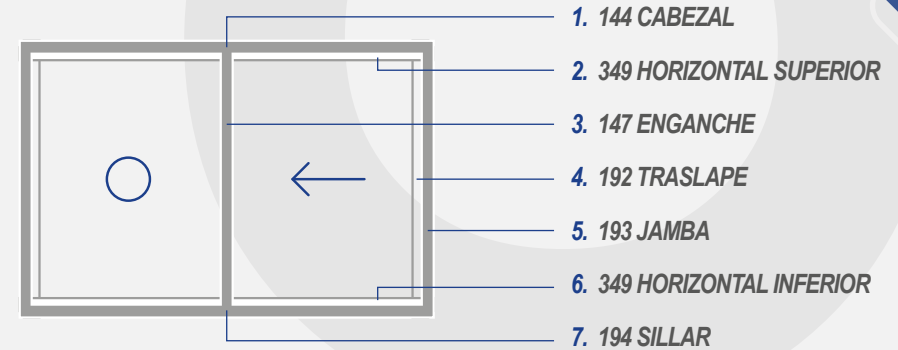

**VENTANA 5020
FÍSICA**

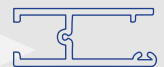

**NOTA: PARA EL HORIZONTAL
SUPERIOR E INFERIOR
SE USA EL MISMO PERFIL**

► Todas las medidas sujetas a modificación por fabricación

**PERFILERÍA EN VENTANA 744
(VISTA EXTERIOR)**

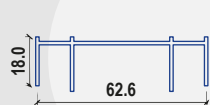
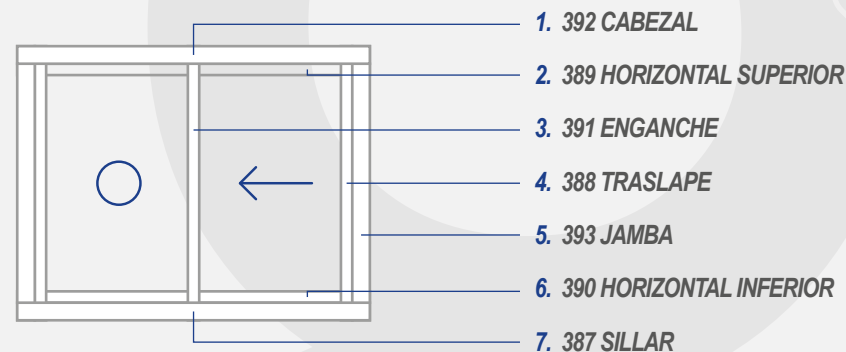

392 CABEZAL

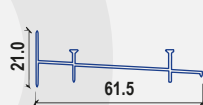

387 SILLAR

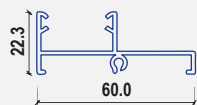

393 JAMBA

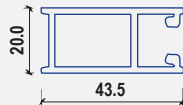

388 TRASLAPE

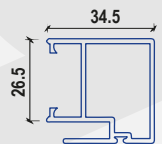

391 ENGANCHE

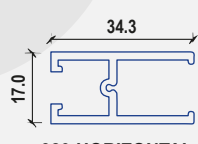

389 HORIZONTAL SUPERIOR

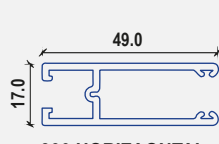

390 HORIZONTAL INFERIOR

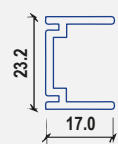

403 ADAPTADOR

SERIE 90

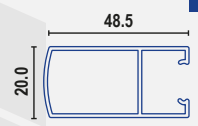

1766
TRASLAPE

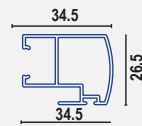

1767
ENGANCHE

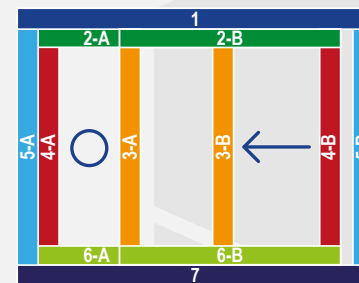

DESPIECE PERFILES VENTANA CORREDIZA 744
(MARCO CON DOS NAVES UNA FIJA Y UNA CORREDIZA)



FIJA



CORREDIZA

- 1. 392 CABEZAL
- 2-A. 389 HORIZONTAL SUPERIOR
- 2-B. 389 HORIZONTAL SUPERIOR
- 3-A. 391 ENGANCHE
- 3-B. 391 ENGANCHE
- 4-A. 388 TRASLAPE
- 4-B. 388 TRASLAPE
- 5-A. 393 JAMBA
- 5-B. 393 JAMBA
- 6-A. 390 HORIZONTAL INFERIOR
- 6-B. 390 HORIZONTAL INFERIOR
- 7. 387 SILLAR

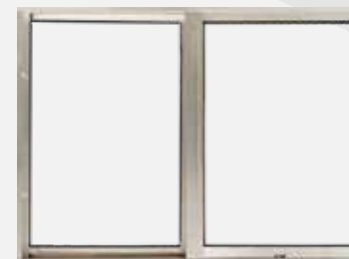

**VENTANA 744
FÍSICA**

▶ Todas las medidas sujetas a modificación por fabricación

PERFILERÍA EN VENTANA 8025
(VISTA EXTERIOR)

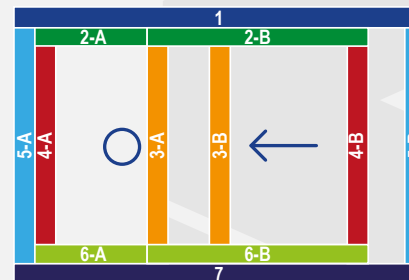
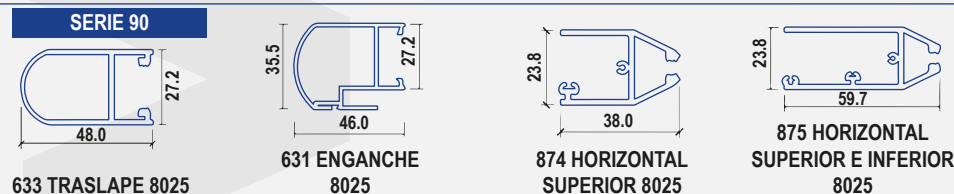
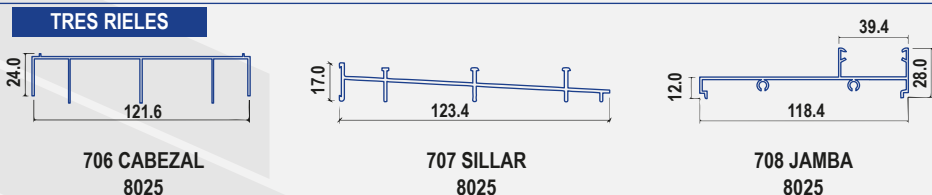
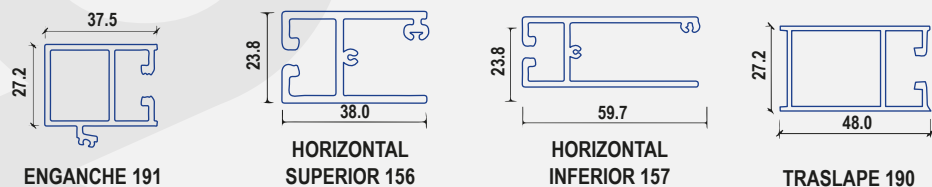
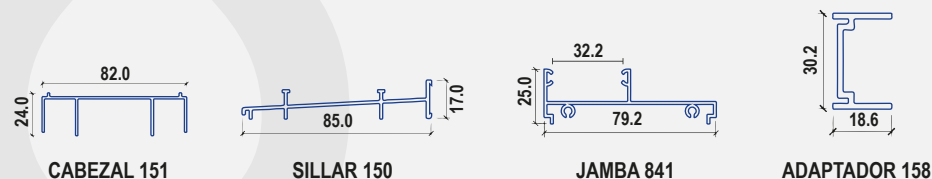
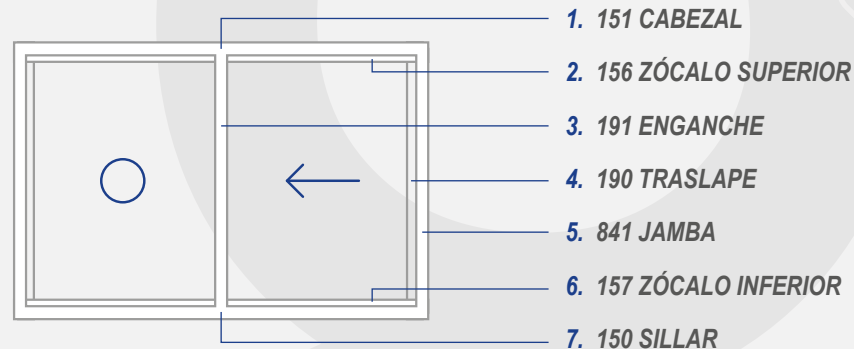

DESPIECE PERFILES VENTANA CORREDIZA 8025
(MARCO CON DOS NAVES UNA FIJA Y UNA CORREDIZA)



1. 151 CABEZAL
- 2-A. 156 ZÓCALO SUPERIOR
- 2-B. 156 ZÓCALO SUPERIOR
- 3-A. 191 ENGANCHE
- 3-B. 191 ENGANCHE
- 4-A. 190 TRASLAPE
- 4-B. 190 TRASLAPE
- 5-A. 841 JAMBA
- 5-B. 841 JAMBA
- 6-A. 157 ZÓCALO INFERIOR
- 6-B. 157 ZÓCALO INFERIOR
7. 150 SILLAR



**VENTANA 8025
FÍSICA**

► Todas las medidas sujetas a modificación por fabricación

PERFILERÍA EN VENTANA 7038 (VISTA EXTERIOR)

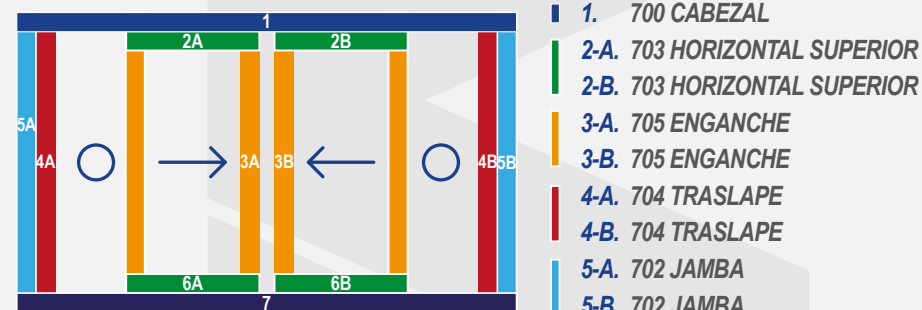
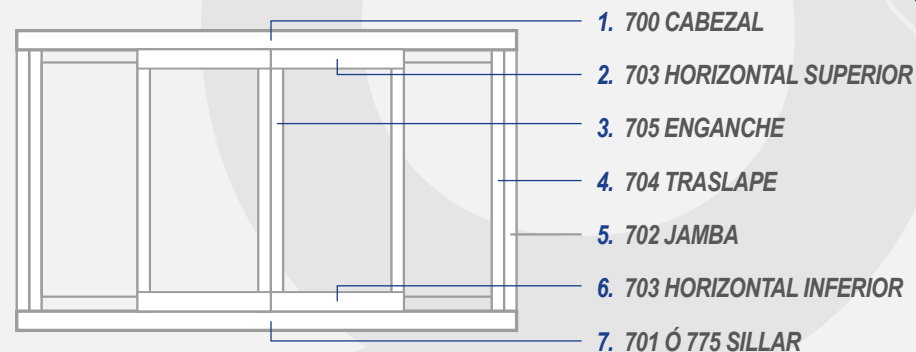

DESPIECE PERFILES PUERTA VENTANA
CORREDIZA 3831
(MARCO CON DOS FIJOS Y DOS CORREDIZAS)

○ FIJA ← CORREDIZA



**VENTANA 7038
FÍSICA**

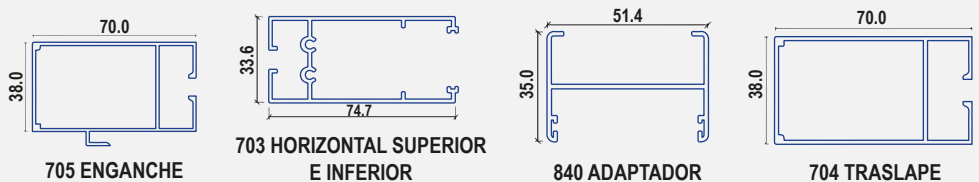
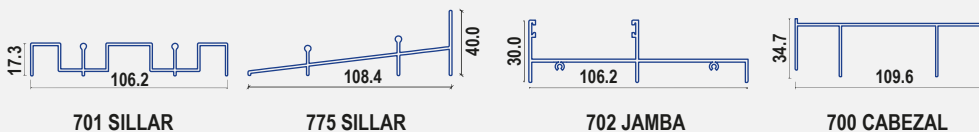

TRES RIELES

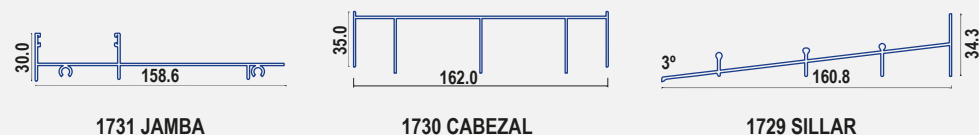

SERIE 90

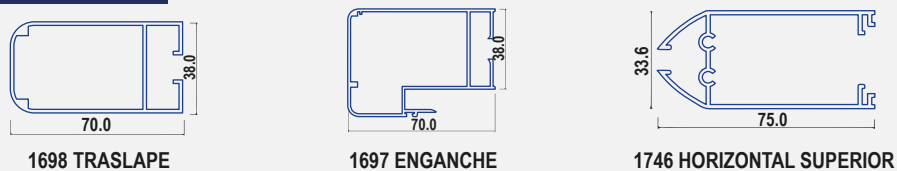

▶ Todas las medidas sujetas a modificación por fabricación

PERFILERÍA EN VENTANA 3831
(VISTA EXTERIOR)

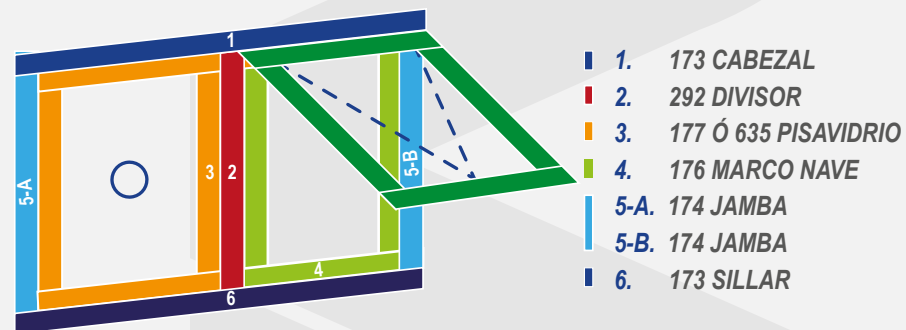
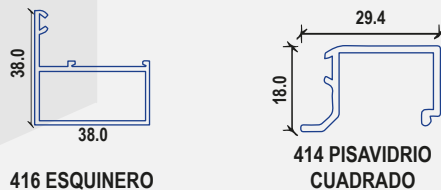
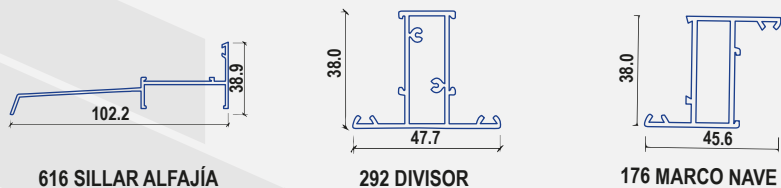
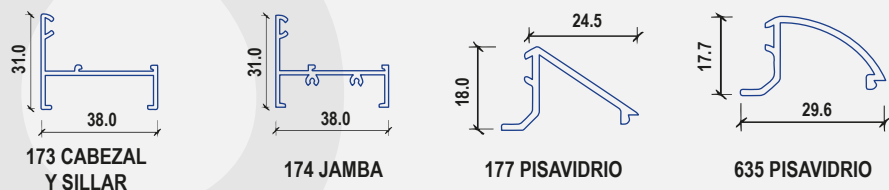
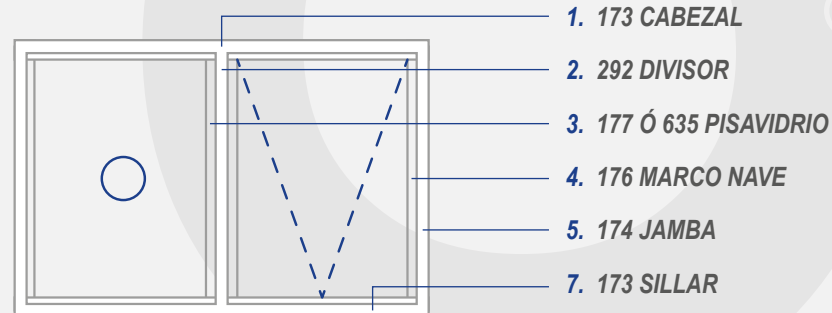

DESPIECE PERFILES VENTANA PROYECTANTE 3831
(MARCO CON UN FIJO Y UNA PROYECTANTE)



**VENTANA 3831
FÍSICA**

► Todas las medidas sujetas a modificación por fabricación

The logo features the letters 'VIALCOR' in a bold, white, sans-serif font. The 'V' is stylized with a double vertical stroke. The 'I' is a simple vertical bar. The 'A' has a wide base. The 'L' is a simple vertical bar. The 'C' is a simple curve. The 'O' is a simple circle. The 'R' is a simple vertical bar with a curved top. The letters are set against a dark blue background with a faint, larger, semi-transparent version of the 'VIALCOR' logo behind them.

VIALCOR

VIALCOR

SOLUCIONES ARQUITECTÓNICAS

www.vialcor.com